

Zoek onderdelen



Alle illustraties en specificaties zijn gebaseerd op de meest recente informatie ten tijde van de publicatie.

*De genoemde prijzen zijn adviesverkoopprijzen exclusief BTW. Montage, transport en mogelijke extra kosten niet inbegrepen.

F65 Eagle Polar White 319-400 - Titanium 400

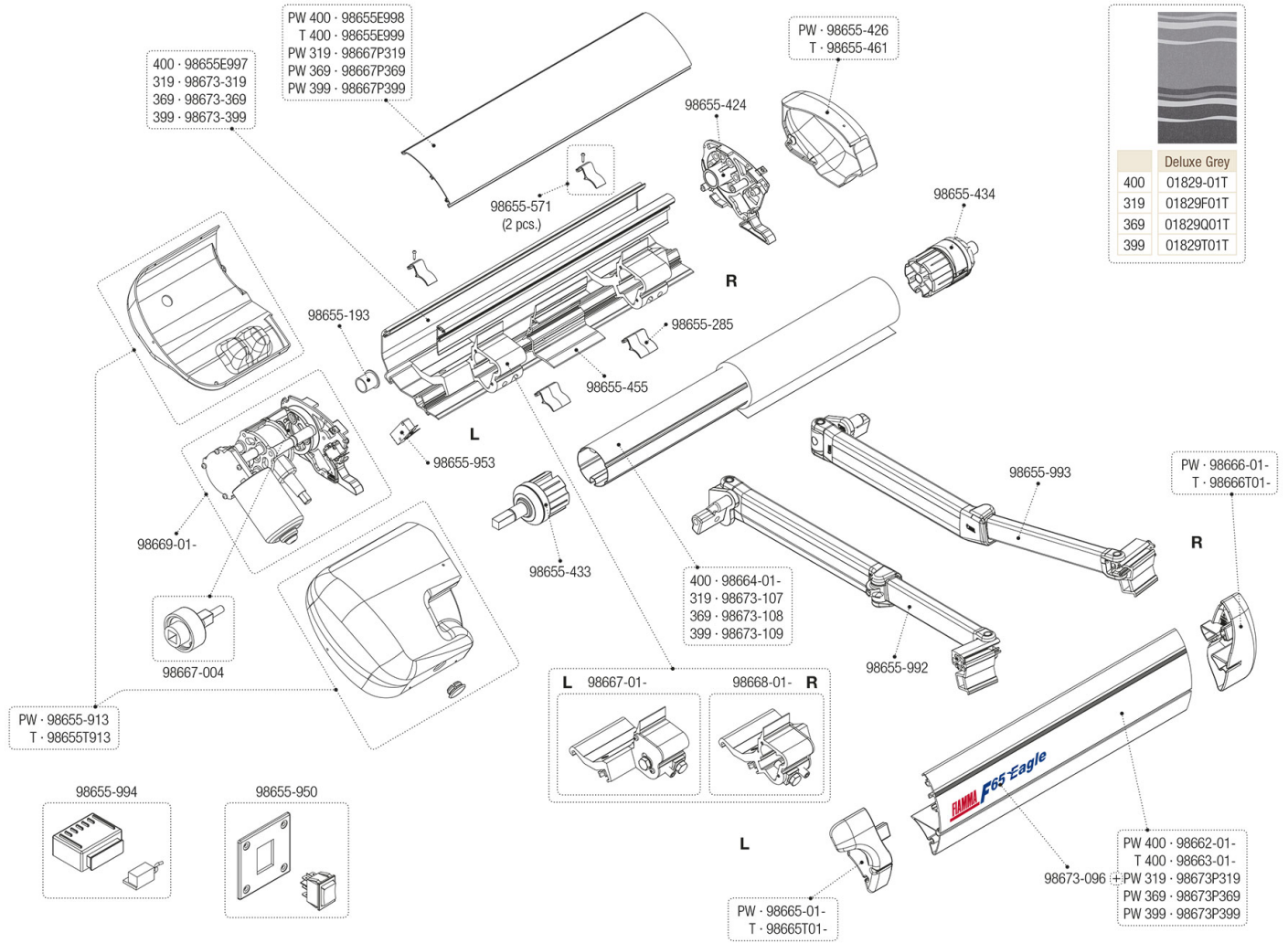

Deluxe Grey	
400	01829-01T
319	01829F01T
369	01829Q01T
399	01829T01T

Code	Omschrijving	Price *
------	--------------	---------

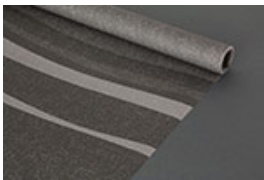
01829-01T	 CANOPY 400 DELUXE GREY F65 EXT.250	€ 249,00
-----------	--	----------

01829F01T	CANOPY 320 DELUXE GREY F65 EXT.250	€ 209,00
-----------	------------------------------------	----------

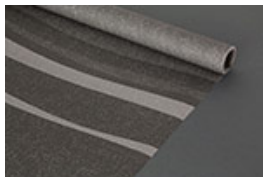

01829Q01T

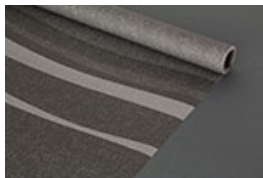

CANOPY 370 DELUXE GREY F65 EXT.250

€ 228,00

01829T01T

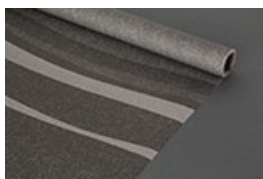

CANOPY 400 DELUXE GREY F45I/F45TI

€ 249,00

98655-193



ROLLER TUBE BUSHING FOR AWNING(1PC)

€ 4,30

98655-424



RIGHT END CAP F65/F65L/F65 EAGLE

€ 16,20

98655-426



RIGHT WINCH COVER F65 POLAR

€ 12,30

98655-433



RIGHT STOP DEVICE D.60

€ 20,90

98655-434

CAP PRESTO FIX D.60

€ 8,10



98655-455



INNER GUIDE CASEBOX F65/L/F65 EAGLE

€ 6,20

98655-461



RIGHT END COVER F65/F65L/EAGLE TIT.

€ 14,20

98655-571



COVER FIXING KIT F65 2PCS

€ 8,80

98655-913



REAR+FRONT COVER MOTORKIT F65 S POL

€ 87,30

98655-950



KIT SWITCH+ PLATE MOTOR-KIT

€ 9,60

98655-953



KIT MICROSWITCH MOTORKIT

€ 28,70

98655-992



LEFT ARM F45 EAGLE 350-450

€ 163,00

98655-993



RIGHT ARM F45 EAGLE 350-450

€ 163,00

98655-994



CONTROL UNIT MOTOR KIT EAGLE

€ 332,00

98655E997



CASE 400 POLAR F65/F65L/F65 EAGLE

€ 223,00

98655E998



TOP CASE 400 F65 POLAR

€ 121,00

98655E999

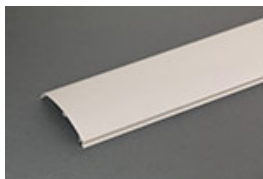

TOP CASE 400 TITANIUM F65/L/EAGLE

€ 159,00

98655T913



REAR+FRONT COVER MOTORKIT F65 TIT

€ 112,00

98662-01-



LEAD BAR F65 L/EAGLE 400 POLAR

€ 222,00

98663-01-



LEAD BAR F65 L/EAGLE 400 TITANIUM

€ 228,00

98664-01-



ROLLER TUBE 400 D.60 F65/EAGLE 400

€ 83,70

98665-01-



LEFT LEAD BAR END CAP F65L POLAR

€ 8,80

98665T01-

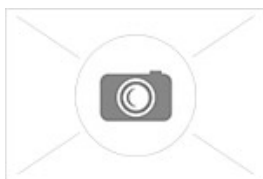

LEFT LEAD BAR END CAP F65L TITANIUM

€ 12,90

98666-01-



R.H. LEAD BAR END CAP F65L POLAR

€ 8,80

98666T01-

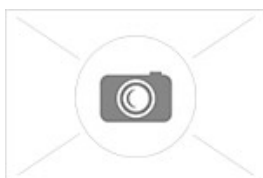

R.H. LEAD BAR END CAP F65L TITANIUM

€ 12,90

98667-004



DIFFERENTIAL GEAR MOTOR KIT

€ 61,20

98667-01-

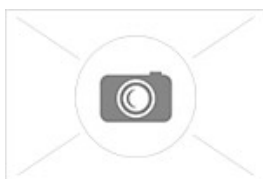

L.H.INNER BRACKET F65 EAGLE

€ 33,60

98667P319

TOP CASE POLAR F65 EAGLE 319

€ 113,00



98667P369



TOP CASE POLAR F65 EAGLE 369

€ 135,00

98667P399



TOP CASE POLAR F65 EAGLE 399

€ 145,00

98668-01-

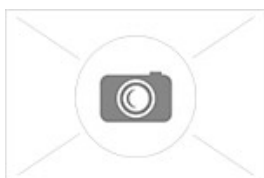

R.H.CASE INNER BRACK.F65 EAGLE

€ 33,60

98669-01-



POWER UNIT MOTORKIT F65/EAGLE

€ 237,00

98673-096



LABEL FIAMMA F65 EAGLE

€ 5,50

98673-107

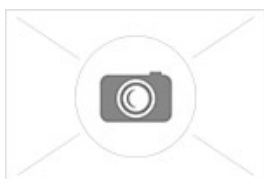

ROLLER TUBE D.60 F65 EAGLE 319

€ 79,70

98673-108

ROLLER TUBE D.60 F65 EAGLE 369

€ 83,60



98673-109



ROLLER TUBE D.60 F65 EAGLE 399

€ 69,20

98673-319

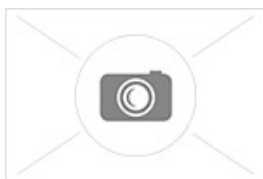

CASE F65 EAGLE 319 DUCATO

€ 131,00

98673-369

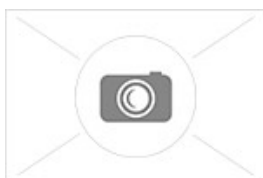

CASE F65 EAGLE 369 DUCATO

€ 204,00

98673-399

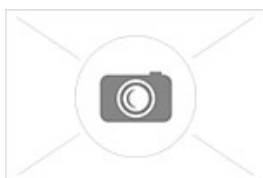

CASE F65 EAGLE 399 DUCATO

€ 223,00

98673P319



LEAD BAR KIT F65 EAGLE 319 POLAR

€ 223,00

98673P369



LEAD BAR KIT F65 EAGLE 369 POLAR

€ 250,00

98673P399

LEAD BAR KIT F65 EAGLE 399 POLAR

€ 250,00

